

Door Loops

Door Loops 700

Model DL-700



Description

The Door Loops are wire extension protector when you install on door frame to the door.

Standard Features

- 700mm long armoured with 7.5mm I.D. flexible steel conduit.
- Attractive Aluminium Alloy housings at each end.
- Aluminium Alloy housing predrilled for wires and concealed mounting screws.
- Specify for transferring electrical current between door and frame.

Specification

	DL-700
Mounting	Surface
Material (Terminal Box)	Aluminium Alloy
Material (Flexible Hose)	Stainless Steel
Maximal door opening angle	180°
Internal diameter	7.5mm
Spiral Length	700 mm
Terminal boxes Size	48 X 40 X 22 mm
Gross Weight	0.16kg

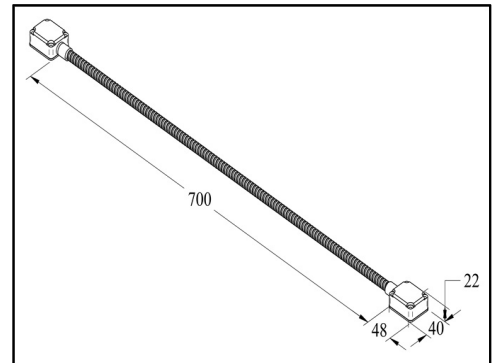

DISCLAIMER:- Specifications are subject to change without prior notice.

- Attached photo is for reference purpose only, actual product may varies.

