



EXT Series

800lbs Water Proof Electromagnetic Lock

Model EXT325-SL (Monitored Version)



Description

800lbs Water Proof EM locks were designed as such to be unaffected / resisting the ingress of water under specified condition with its fully sealed electronics incased with stainless steel. Suitable for outdoor application and harsh climate.

Standard Features



Fail Safe

Life Safety Applications



Zero Residual Magnetism

No Residual



Low Power

Low Energy Consumption



Low Maintenance

Cost Savings

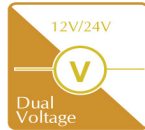

12V/24V
Dual Voltage

12/24V Selectable



Waterproof

Fully Sealed Electronics

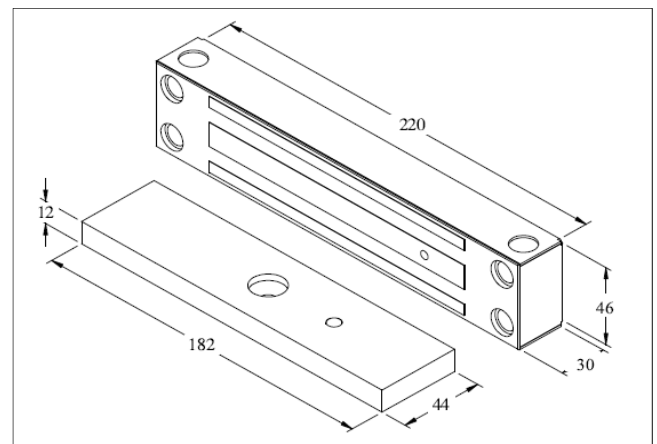

Features & Technical Specification

Models	EXT325-SL
Features & Spec.	
Lock Status Monitoring	Reed Switch
Holding Force	Up to 800lbs
Magnet Size	220 X 46 x 30 mm
Armature Size	182 X 44 X 12 mm
Current Drain	460mA±10%/12Vdc / 230mA±10%/24Vdc
Temperature	(-10 to 55) °C (14 to 131) °F
Housing	Stainless Steel Housing
Weight	2.9 Kg

Wiring Diagram

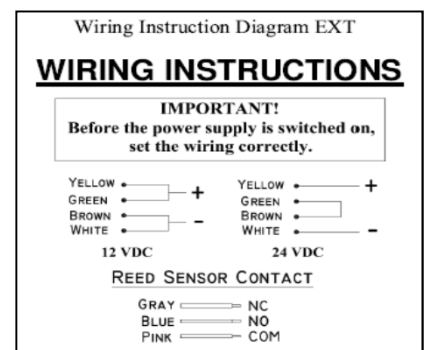

WARRANTY:- Algatec EM Lock are warranted against defects in material and workmanship while used in normal service for a period of 5 years from the date of sale to the original customer.

DISCLAIMER:- Specifications are subject to change without prior notice.

- Attached photo is for reference purpose only, actual product may varies.

