

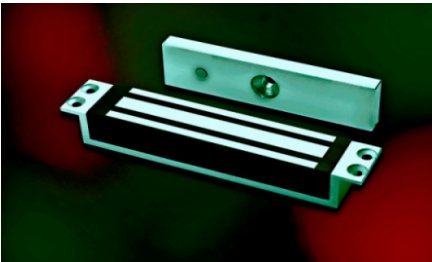

# Mortice Series

## 300lbs Mortice Electromagnetic Lock

Model **UL135-M (Unmonitored Version)**  
**UL135-ML (Monitored Version)**



### Description

300lbs Mortice EM locks were designed to meet fire/life safety applications by providing an auxiliary locking mechanism that has no moving parts to bind or wear out for trouble free operation. This will ensure inhibited release at all times where they have become extremely prevalent in applications other than fire/life safety. Specially designed for flush mount applications access control.

### Standard Features



Life Safety Applications



No Residual



Low Energy Consumption



Cost Savings

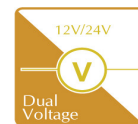

12/24V Selectable



Ideal for all door type

### Extended Features

(Optional)

- Lock Status Monitoring
- Anodized Aluminium Housing
- CE Compliance

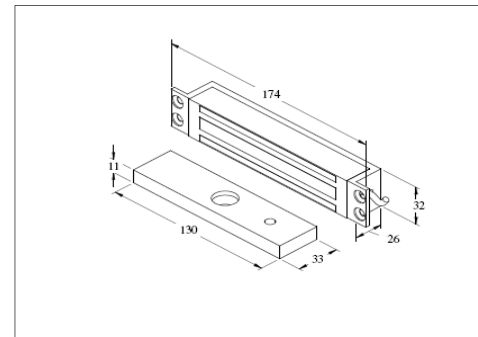

### Specification

	UL135-M / UL135-ML
<b>Magnet Size</b>	174 X 32 X 26 mm
<b>Armature Size</b>	130 X 33 X 11 mm
<b>Holding Force</b>	Up to 300lbs
<b>Current Drain</b>	300mA±10%/12Vdc / 150mA±10%/24Vdc
<b>Temperature</b>	(-10 to 55)°C (14 to 131)°F
<b>Weight</b>	1.3kg

### Wiring Diagram

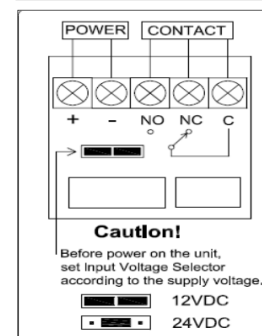

**WARRANTY:-** Algatec EM Lock are warranted against defects in material and workmanship while used in normal service for a period of 5 years from the date of sale to the original customer.

**DISCLAIMER:-** Specifications are subject to change without prior notice.

- Attached photo is for reference purpose only, actual product may varies.

